

INSTRUCTION MANUAL

LED CEILING LIGHT DIMMABLE & 3 IN 1 CCT

TECHNICAL DATA

MODEL	VT-84023
SKU	24188, 24189, 24190
WATTS	48W
LUMENS SPHERE360°	5760 Lm
BEAM ANGLE	120°
LIFE SPAN	20,000 Hours
ON/OFF CYCLE	>15,000 Times
CCT	3000K/4000K/6000K
MATERIAL	Metal+Acrylic
IP RATING	IP20
CRI	>80
INPUT VOLTAGE	AC: 220-260V, 50Hz
DIMENSION	Ø450xH120mm



*This product contains a light source of energy efficiency class<E>, where <E> shall be replaced by the energy class of the contained light source.

INTRODUCTION & WARRANTY

Thank you for selecting and buying V-TAC product. V-TAC will serve you the best. Please read these instructions carefully before starting the installation and keep this manual handy for future reference. If you have any another query, please contact our dealer or local vendor from whom you have purchased the product. They are trained and ready to serve you at the best. The warranty is valid for 2 years from the date of purchase. The warranty does not apply to damage caused by incorrect installation or abnormal wear and tear. The company gives no warranty against damage to any surface due to incorrect removal and installation of the product. The products are suitable for 10-12 Hours Daily operation. Usage of product for 24 Hours a day would void the warranty. This product is warranted for manufacturing defects only.

WARNING

- Please make sure to turn off the power before starting the installation.
- Installation must be performed by a qualified electrician.
- The light source contained in this luminaire shall only be replaced by the manufacturer or his service agent or a similar qualified person.
- Proper grounding should be ensured throughout the installation.
- For Indoor Use only

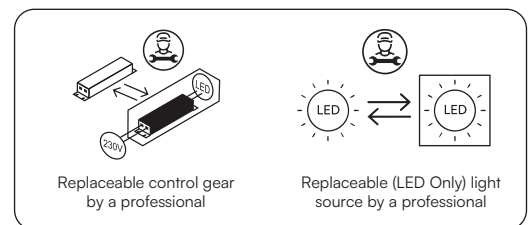

MULTI-LANGUAGE MANUAL QR CODE

Please scan the QR code to access the manual in multiple languages.



Points de collecte sur www.quefairedemesdechets.fr
Privilégiez la réparation ou le don de votre appareil !



This marking indicates that this product should not be disposed of with other household wastes.

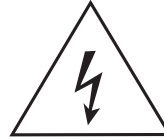

Caution, risk of electric shock.

INSTALLATION DIAGRAM

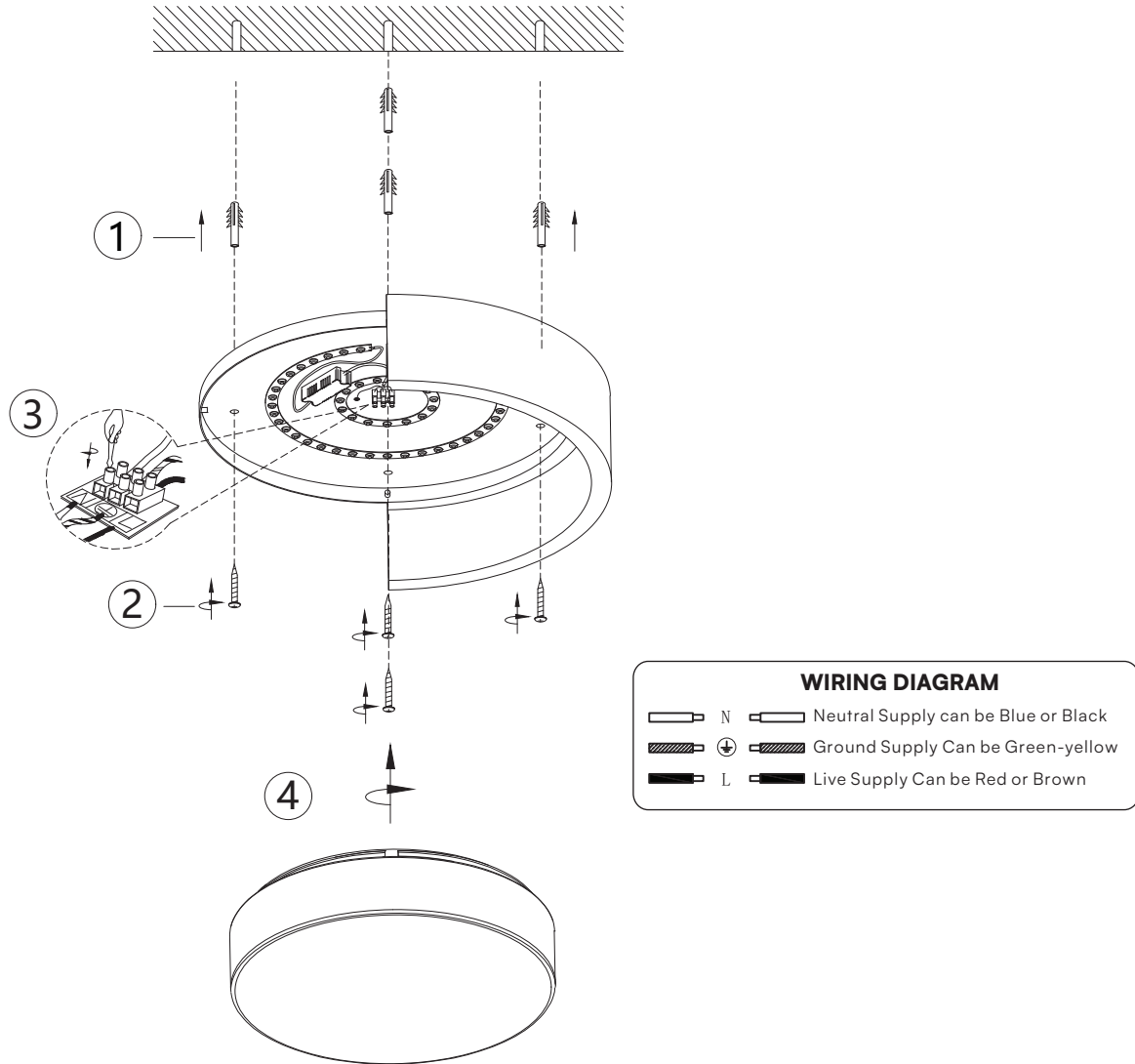

INSTALLATION INSTRUCTIONS

1. Switch off the power before starting the installation.
2. Use screws to fix mounting bar to the junction box.
3. Make the wire connections with connectors.
 - Connect the live wire (L) from fitting to the live wire from main power supply.
 - Connect the neutral wire (N) from fitting to the neutral wire from main power supply.
 - Connect the earth wire from fitting to the earth wire from main power supply.
 - Please pay close attention and make sure the wires are not exposed outside when wiring connections.
4. Use screws to fix canopy to mounting bar.
5. Check if the installation is completed and turn on the power.

DISMANTLING INSTRUCTIONS

(For Market surveillance team only)

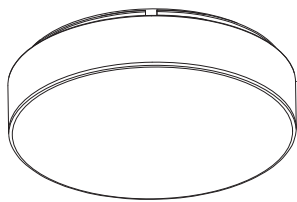
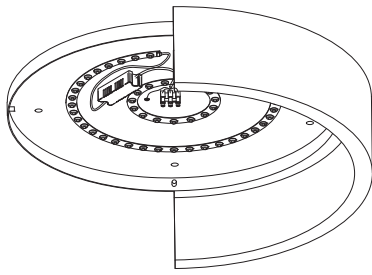

1. Disassemble the lampshade.

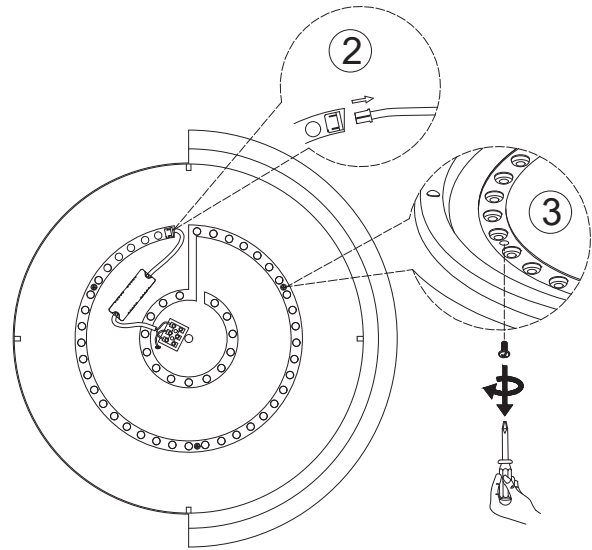

2. Remove the SM terminals on the driver and LED strip.
3. Remove the screws of the LED strip.

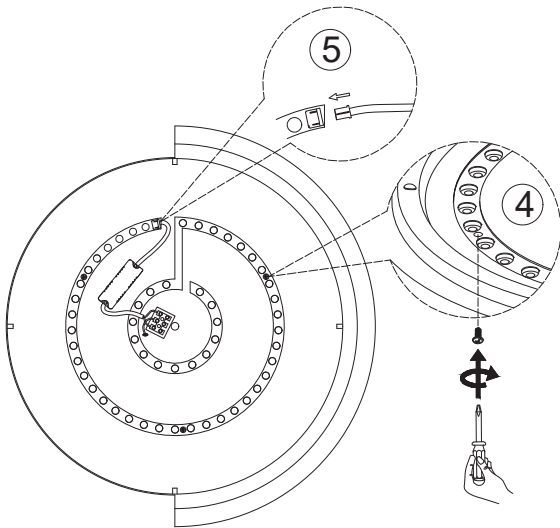

4. Install a new LED strip and secure it with screws.
5. Connect the SM terminal of the driver and LED strip.

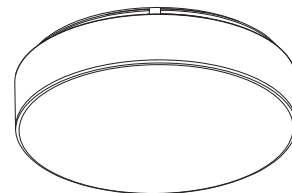
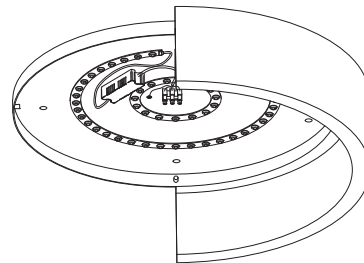

6. Install the lampshade.

Note: Light source removal will void the warranty

REMOTE CONTROL INSTRUCTIONS

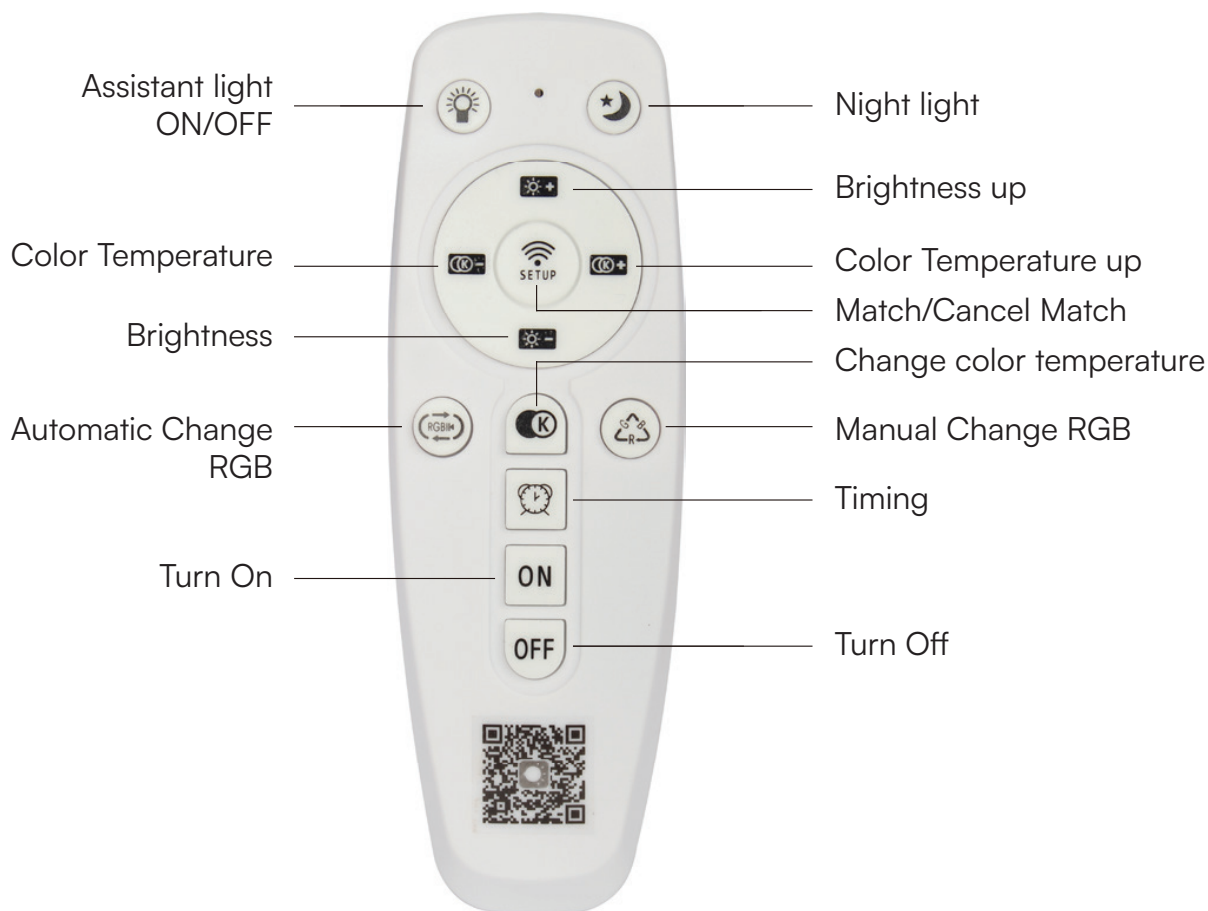

Note: AAA battery required for remote control (battery not included).

REMOTE CONTROL SAFETY INSTRUCTIONS

- Before using this product, make sure that all parts are configured correctly according to the instructions in the attached instruction.
- The product should not be used by persons under 5 years of age without supervision by a parent or guardian.
- Ensure that the power batteries are configured correctly and have the appropriate parameters as specified by the manufacturer.

APP INSTALLATION - LAMPSMART PRO

To install the LampSmart Pro application, scan the provided QR code using your mobile device. Follow the on-screen instructions to complete the installation process.

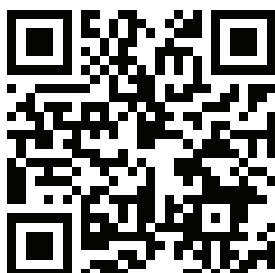

LampSmart
Pro

APP CONTROL INSTRUCTIONS

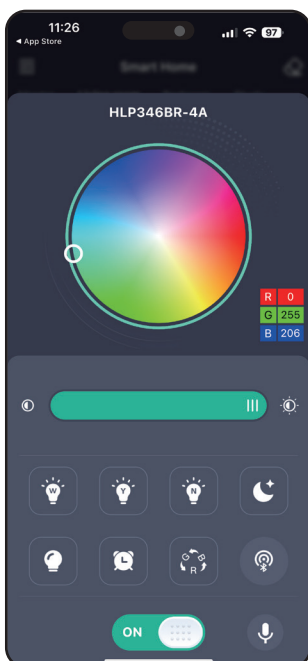
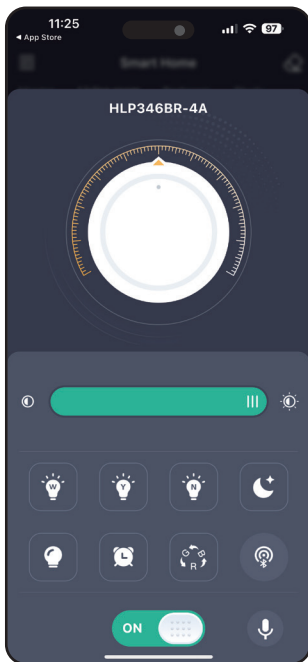

Pair button. Click this button within 5 seconds after the device is powered on. If the device flashes or beeps, it means that the phone has been successfully paired with the device, and then the device can be controlled through the application.



The state of the lamp can be adjusted by voice commands. Currently only Chinese and English are supported.



Change the color temperature of the light.



Change the brightness of the light.



After clicking the light color will change in a cycle. (Not supported)



Click to select a time to turn off the device.



Click to turn on the auxiliary light. (Not supported)



Night mode. The white light and the yellow light will light up at the same time, but only at 10% of the maximum brightness.



When clicked, the white light and yellow light will light up at the same time, and the brightness will be the maximum brightness.



When clicked, only yellow light will light up, and the brightness will be the maximum brightness.



When clicked, only white light will light up, and the brightness will be the maximum brightness.

- Swipe the upper part of the page to the left to switch to the RGB lamp control page. (The RGB feature is not supported by this product)
- The RGB lamp control page can adjust the color of the RGB lamp. (Not supported)
- The RGB lamp control page can adjust the brightness of the RGB lamp. (Not supported)

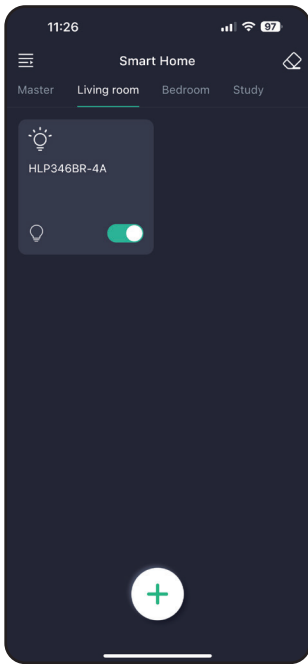

Unpair Button: Click this button within 5 seconds when the device is powered on. If the device flashes or beeps, it means that the phone is unpaired with the device and the phone will not be able to control the device.

MASTER: Room control page. When there are devices in the room, all the devices in the room can be controlled in this page. As the above example, all the device in the living room can be controlled.

When in the room page, long press the device card you can delete the device or change the device name.



V-TAC WEST EUROPE LTD. IN CASE OF ANY QUERY/ISSUE WITH THE PRODUCT, PLEASE REACH OUT TO US AT:
SUPPORT@V-TAC.EU FOR MORE PRODUCTS RANGE, INQUIRY PLEASE CONTACT OUR DISTRIBUTOR OR NEAREST DEALERS.
V-TAC WEST EUROPE LTD. GROUND FLOOR, 71 LOWER BAGGOT STREET, DUBLIN 02, IRELAND DO2 P593

V-TAC UK LTD. IN CASE OF ANY QUERY/ISSUE WITH THE PRODUCT PLEASE REACH OUT TO US AT:
SUPPORT@VTACEXPORTS.COM V-TAC, 5A TUNGSTEN PARK, DOWNS ROAD, WITNEY, OXFORDSHIRE, OX29 0AX