

V-TAC

Meaningful Innovation.

WEEE Number: 80133970

INSTRUCTION MANUAL LED CEILING LIGHT

TECHNICAL DATA

MODEL	VT-84035
SKU	24174
POWER	70W
INPUT VOLTAGE	AC 220-265V, 50/60Hz
USEFUL LUMEN	5600Lm (@SPHERE 360°)
BEAM ANGLE	180°
LIFE SPAN	20,000 Hours
ON/OFF CYCLE	>15,000 Times
UNIT COLOUR	White
LED COLOUR	3000K-6500K(Changeable)
CRI	>80
IP RATING	IP20
DIMENSION	500*500*43mm

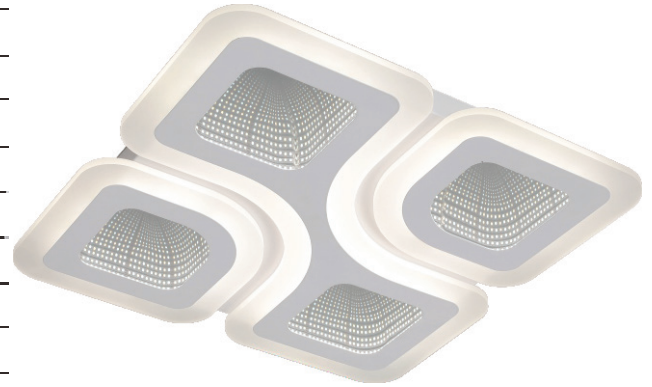

02 YEAR
WARRANTY*



INTRODUCTION & WARRANTY

Thank you for selecting and buying V-TAC product. V-TAC will serve you the best. Please read these instructions carefully before starting the installation and keep this manual handy for future reference. If you have any another query, please contact our dealer or local vendor from whom you have purchased the product. They are trained and ready to serve you at the best. The warranty is valid for 2 years from the date of purchase. The warranty does not apply to damage caused by incorrect installation or abnormal wear and tear. The company gives no warranty against damage to any surface due to incorrect removal and installation of the product. The products are suitable for 12-10 Hours Daily operation. Usage of product for 24 Hours a day would void the warranty. This product is warranted for manufacturing defects only.

WARNING

1. Please turn off power and read this instruction before starting the installation.
2. Installation should only be done by a certified electrician.
3. The light source of this luminaire is not replaceable; when the light source reaches its end of life the whole luminaire shall be replaced.
4. Proper grounding should be ensured throughout the installation.
5. For Indoor use only.

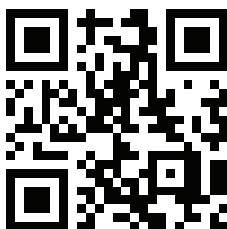

MULTI-LANGUAGE MANUAL QR CODE

Please scan the QR code to access the manual in multiple languages.



FR

Cet appareil, ses accessoires et cordons se recyclent

À DÉPOSER EN MAGASIN

À DÉPOSER EN DÉCHÈTERIE



OU



Points de collecte sur www.quefairedemesdechets.fr
Privilégiez la réparation ou le don de votre appareil !



This marking indicates that this product should not be disposed of with other household wastes.

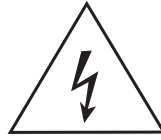

Caution, risk of electric shock.

INSTALLATION DIAGRAM

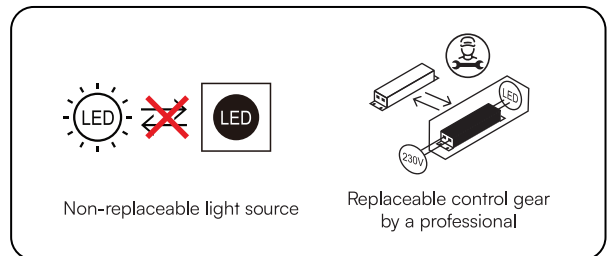
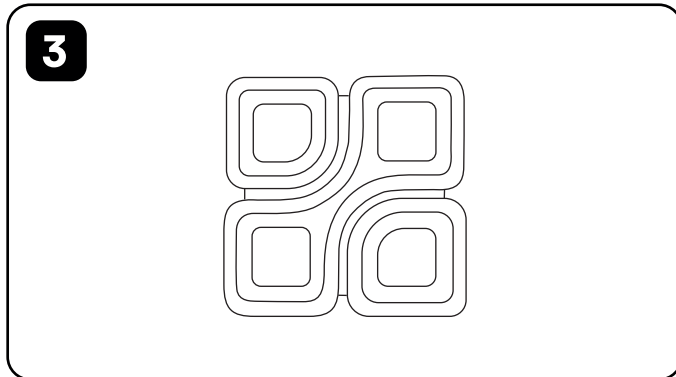
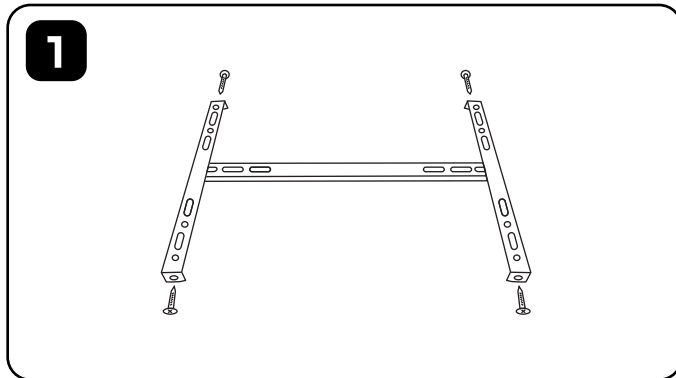

INSTALLATION INSTRUCTIONS

1. Turn off the power before starting the installation.
2. Fix the base with screws by drilling holes in the ceiling
3. Connect the power supply to the AC as per the diagram provided.
4. Fix the lamp to the base.
5. Turn on the power and test the lamp.

REMOTE CONTROL SAFETY INSTRUCTIONS

- Before using this product, make sure that all parts are configured correctly according to the instructions in the attached instruction.
- The product should not be used by persons under 5 years of age without supervision by a parent or guardian.
- Ensure that the power batteries are configured correctly and have the appropriate parameters as specified by the manufacturer.

REMOTE CONTROL INSTRUCTIONS

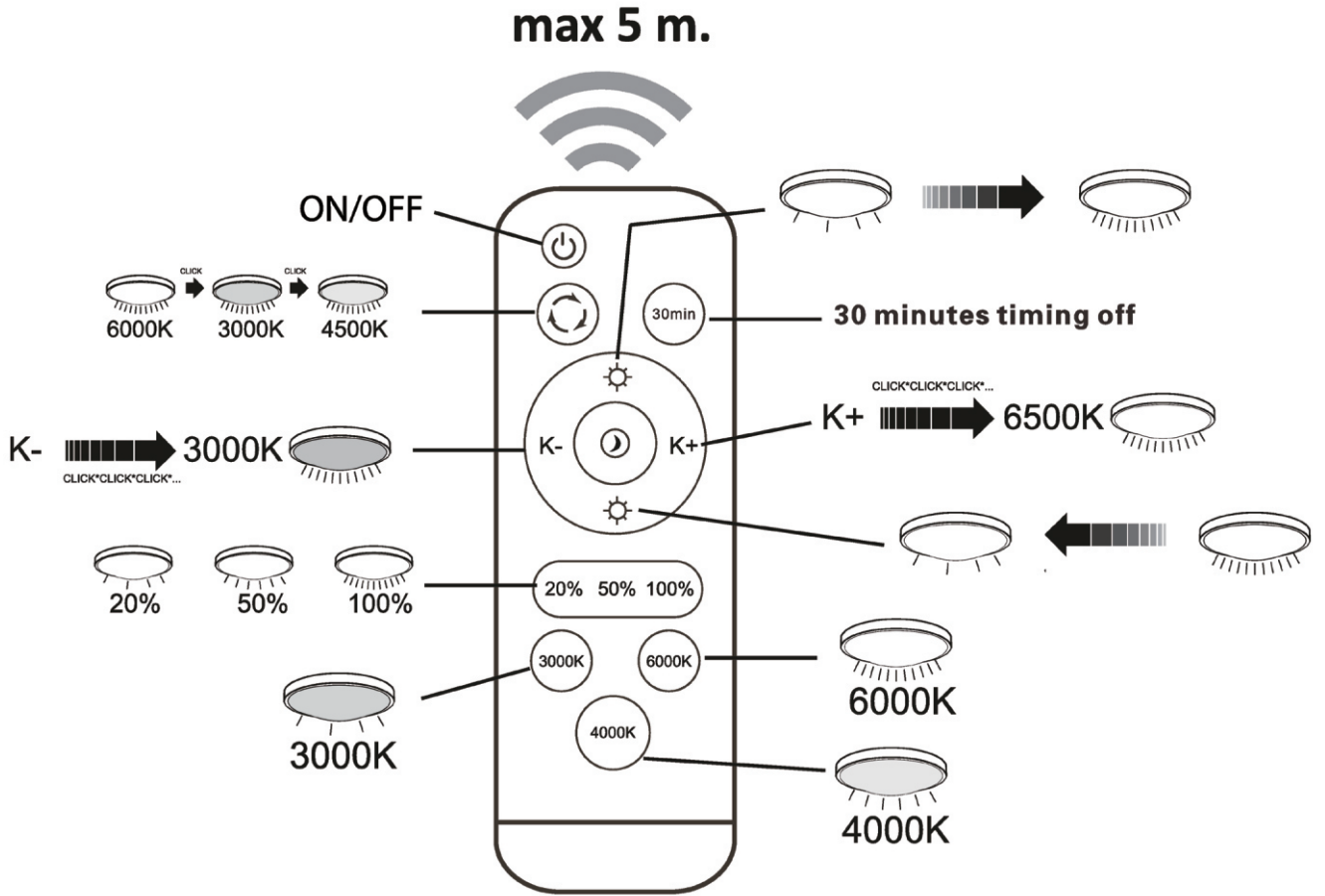

V-TAC WEST EUROPE LTD. IN CASE OF ANY QUERY/ISSUE WITH THE PRODUCT, PLEASE REACH OUT TO US AT: SUPPORT@V-TAC.EU FOR MORE PRODUCTS RANGE, INQUIRY PLEASE CONTACT OUR DISTRIBUTOR OR NEAREST DEALERS. V-TAC WEST EUROPE LTD. GROUND FLOOR, 71 LOWER BAGGOT STREET, DUBLIN O2, IRELAND DO2 P593

V-TAC UK LTD. IN CASE OF ANY QUERY/ISSUE WITH THE PRODUCT PLEASE REACH OUT TO US AT SUPPORT@VTACEXPORTS.COM V-TAC, 5A TUNGSTEN PARK, DOWNS ROAD, WITNEY, OXFORDSHIRE, OX29 0AX