



Meaningful Innovation.

WEEE Number: 80133970

INSTRUCTION MANUAL

RACKABLE LFP BATTERY SERIES



MODEL	VT-51201-B
SKU	12327

5 YEAR WARRANTY*

INTRODUCTION

Thank you for selecting and buying V-TAC Product. V-TAC will serve you the best. Please read these instructions carefully & keep this user manual handy for future reference. If you have any another query, please contact our dealer or local vendor from whom you have purchased the product. They are trained and ready to serve you at the best.



MULTI-LANGUAGE MANUAL QR CODE
Please scan the QR code to access the manual in multiple languages.



FR
Les piles et batteries se recyclent

À DÉPOSER EN MAGASIN

À DÉPOSER EN DÉCHÈTERIE

OU

Points de collecte sur www.quefairedemesdechets.fr



IN CASE OF ANY QUERY/ISSUE WITH THE PRODUCT, PLEASE REACH OUT TO US AT: SUPPORT@V-TAC.EU
FOR MORE PRODUCTS RANGE, INQUIRY PLEASE CONTACT OUR DISTRIBUTOR OR NEAREST DEALERS.
V-TAC EUROPE LTD. BULGARIA, PLOVDIV 4000, BUL.L.KARAVELOW 9B

How to Use This Manual

Read the manual and other related documents before performing any operation on the battery.

Documents must be stored carefully and be always available.

Contents may be periodically updated or revised due to product development. The information in this manual is subject to change without notice.

All Rights Reserved

No part of this document can be reproduced in any form or by any means without the formal permission of the manufacturer.

Trademarks and Permissions

Trademarks used in this manual are owned by the manufacturer. All other trademarks or registered trademarks mentioned in this manual are owned by their respective owners.

Software Licenses

* It is prohibited to use data contained in firmware or software developed by the manufacturer , in part or in full, for commercial purposes by any means.

* It is prohibited to perform reverse engineering, cracking, or any other operations that compromise the original program design of the software developed by the manufacturer.

Disclaimer

The manufacturer shall not be liable for personal injury, property loss, product damage and subsequent losses under the following circumstances:

* Damages caused by force majeure, including earthquake, flood, volcanic eruption, mudslide,, lightning, fire, war, military conflict, typhoon, hurricane, and so on.

* Failure to comply with the provisions of this manual.

* The installation, operation and storage environment does not meet the relevant international, national or regional standards;

* Incorrect use of this product.

* Unauthorized or unqualified personnel repair the product, disassembly the rack and perform other operations.

* Use of unapproved spare parts.

* Unauthorized modifications or technical changes to the product or software.

* Incorrect shipment by yourself or the third party commissioned by you.

* Unsatisfactory materials and tools from you own that do not meet the relevant international, national or regional standards.

* Damage caused by yourself or the third party's negligence, intent, gross negligence, or improper operation.

Contents

1 Safety Instructions.....	4
1.1 Terms and Symbols.....	4
1.2 Installation Precautions.....	6
2 Product Description.....	6
2.1 Product Features.....	6
2.2 Product Overview.....	6
2.3 State Indicator.....	7
2.4 Terminal definition.....	8
3 Preparation for Installation.....	9
3.1 Unpacking List.....	9
3.2 Required Tools.....	11
3.2 Safety Gear.....	11
4 Installation Instructions.....	12
4.1 Installation Personnel.....	12
4.2 Installation Environment.....	12
4.3 Installing the Battery.....	14
4.3.1 Wall-mounted.....	14
4.3.2 Floor-mounted.....	17
4.3.3 Rack-mounted.....	17
5. Electrical Connection.....	18
5.1 Wiring.....	18
5.2 Connecting to PCS.....	19
5.3 Parallel Mode.....	20
5.3.1 Mode 1.....	20
5.3.2 Mode 2.....	22
6 Power on/off the Product.....	23
7 Inspection, Cleaning and Maintenance.....	23
7.1 General Information.....	23
7.2 Inspection.....	23
7.3 Cleaning.....	24
8 Storage.....	24
9 Troubleshooting.....	25
10 Technical Specifications.....	26
11 Environmental Disposal.....	27
12 Transportation Requirements.....	27
13 EU Declaration of Conformity.....	28













1 Safety Instructions







Warning!

Read and follow carefully all safety warnings and all instructions . Failure to do so may result in electrical shock, fire, serious injury, or death. Save these instructions for future reference.

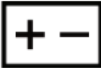
1.1 Terms and Symbols

Terms /Symbols	Description
 Danger	Indicates a hazard with a high level of risk which, if not avoided, will result in death or serious injury.
 Warning	Indicates a hazard with a medium level of risk which, if not avoided, will result in death or serious injury.
 Caution	Indicates a hazard with a low level of risk which, if not avoided, will result in minor or moderate injury.
 Notice	Indicates a potentially hazardous situation which, if not avoided, could results in equipment damage, data loss, performance deterioration, or unanticipated results. NOTICE is used to address practices not related to personal injury.
 Note	Supplements the important information in the main text. NOTE is used to address information not related to personal injury, equipment damage, and environment deterioration.
	Caution , risk of electric shock symbol indicates important safety instructions , which if not correctly followed , could result in electric shock.
	The DC input terminals of the inverter must not be grounded.
	Surface high temperature , Please do not touch the inverter case .
	CE mark of conformity
	Please read the instructions carefully before use .
	Indicate that this product is recyclable
	Do not place near open fire or incinerate. Do not use near heaters or hot temperature source.

	Attention! The risk of explosion.
	Li-ion battery
	Do not tread
	Do not run and chase
	Do not touch with your palm
	Symbol for the marking of electrical and electronics devices according to Directive 2002/96/ EC. Indicates that the device , accessories and the packaging must not be disposed as unsorted municipal waste and must be collected separately at the end of the usage . Please follow Local Ordinances or Regulations for disposal or contact an authorized representative of the manufacturer for information concerning the decommissioning of equipment.

1.2 Safety Rules

The product provides a safe source of electrical energy when operated as intended and as designed. Potentially hazardous circumstances such as excessive heat or electrolyte mist may occur under improper operating conditions, damage, misuse and/or abuse. The following safety precautions and the warning messages described in this part must be observed.

If any of the following precautions are not fully understood, or if you have any questions, contact us for guidance.

Risks of explosion

- Do not subject the battery to strong impacts.
- Do not crush or puncture the battery.
- Do not dispose of the battery in a fire.

Risks of fire

- Do not expose the battery o temperatures in excess of 60°C.
- Do not place the battery near a heat source such as a fireplace.
- Do not expose the battery to direct sunlight.
- Do not allow the battery connectors to touch conductive objects such as wires.

Risks of electric shock

- Do not disassemble the battery.
- Do not touch the battery with wet hands.
- Do not expose the battery to moisture or liquids.
- Keep the battery away from children and animals.

Risks of damage to the battery

- Do not allow the battery to encounter liquids.
- Do not subject the battery to high pressures.

1.2 Installation Precautions

Please be aware that a battery presents a risk of electrical shock including high short-circuit current.

Follow all safety precautions while operating the batteries.

- Remove watches, rings, and other metallic accessories.
- Use tools with insulated handles in order to avoid inadvertent short circuits.
- Wear rubber gloves and safety boots.
- Do not put tools or any metal parts on the top of the batteries.
- Disconnect charging source and load before connecting or disconnecting terminals.
- When moving batteries and wear all appropriate safety clothing and equipment.
- Do not open or mutilate the batteries.



Caution!

- Verify polarity at all connections before energizing the system. Reverse polarity at the battery terminals will void the Warranty and destroy the batteries. Do not short circuit the batteries.
- Do not combine Lithium Batteries with other brands or chemistries;
- Do not mix Lithium Batteries from different installations, clients, or job sites.
- Do not disassemble or modify the battery. If the battery housing is damaged, do not touch exposed contents.

2 Product Description

2.1 Product Features

51.2V series lithium iron phosphate battery system has been designed to provide power backup for remote or outside telecom plants like Access Terminals, Base Transceiver Stations, and Base Station Controllers. This system has the characteristics of high system integration, well reliability, long service life, and wide operating temperature range.

2.2 Product Overview

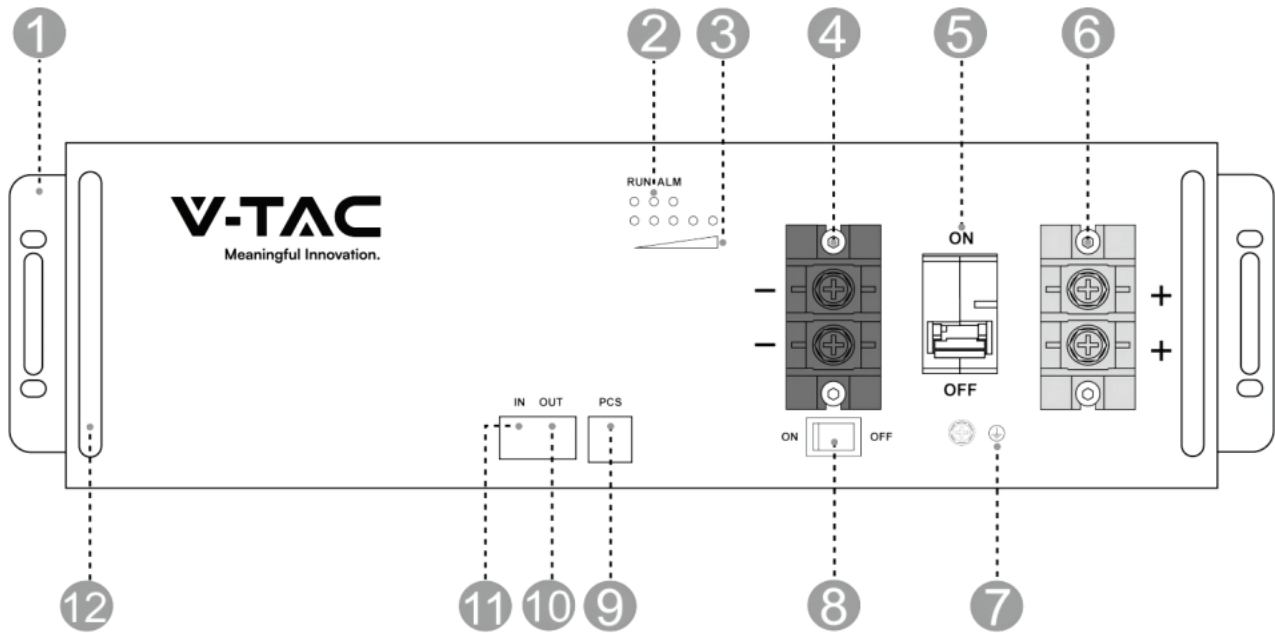

①	Used for fixing with cabinet.
②	RUN light: green LED lighting to show the battery running status. Alarm light: yellow LED lighting to show the battery has been alarmed. Error: red LED lighting to show the battery has been protected.
③	SOC: used to display the state of remaining charge by 5 LEDs. The lightning of these LEDs indicates the SOC of 20%, 40%, 60%,80% and 100%.
④	Negative output terminal.
⑤	Circuit breaker: to control manually the connection between the battery and external devices.
⑥	Positive output terminal.
⑦	Ground
⑧	BMS switch: to turn on/off the whole battery
⑨	PCS: Inverter communication terminal (RJ45 port) follow the CAN protocol (baud rate: 500kbps), and RS-485(baud rate: 9600bps), used to output battery information to the inverter.
⑩	OUT: parallel Communication Terminal: (RJ45 port) Connect "IN" terminal of next battery, for communication between multiple parallel batteries.
⑪	IN: parallel Communication Terminal: (RJ45 port) Connect "OUT" terminal of previous battery, for communication between multiple parallel batteries.
⑫	Handle

2.3 State Indicator

Condition	RUN	ALM	ERROR	SOC1	SOC2	SOC3	SOC4	SOC5	
Power Off	Off								
Discharge or Idle	Blink	Blink if Alarm Exists	Off	e.g., SOC67%					
			Off	On	On	On	On		
Charge		Blink	Blink if Alarm Exists	Off	e.g., SOC47%:				
				Off	Off	Blink	On	On	
Alarm	Blink	Blink	Off	Same as 'Discharge or Idle'					
System Error/Protection			On						
Upgrade	Blink quickly								
Critical Error	Blink slowly								

2.4 Terminal definition

(1) PCS Port definition

Definition of PCS Port Pin

No.	PCS Port Pin
1	485-B
2	485-A
3	-
4	CANH
5	CANL
6	-
7	485-A
8	485-B



(2) IN Port definition

Definition of IN Port Pin

No.	PCS Port Pin
1	CANL
2	CANH
3	DI+
4	DI-
5	DI-
6	DI+
7	CANH
8	CANL



(3) OUT Port definition

Definition of Out Port Pin



No.	Out Port Pin
1	CANL
2	CANH
3	DO+
4	DO-
5	DO-
6	DO+
7	CANH
8	CANL



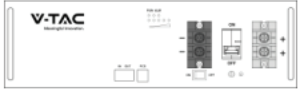
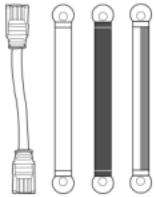

3 Preparation for Installation

After unpacking, check that packing contents are intact and complete, and free from any damage. If any item listed in the Unpacking List is missing or damaged, contact your vendor.



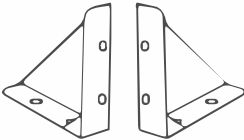
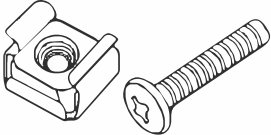
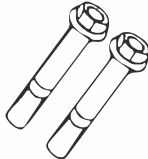

3.1 Unpacking List

No.	Items	Appearance	Usage	Qty.
1	Battery		Provide power	1
2	BCable		270mm 4AWG negative battery power cable; 270mm 4AWG positive battery power cable; 250mm RJ45 communication cable ; 250mm 10AWG yellow-green ground cable.	1
3	PCable		Pair of 4AWG and RJ45 communication cable to connect with hybrid inverter. The cable length can be customized based on customer requirements. Default length is 1500mm.	1

4	Hanging ears		Pair of hanging ears used for battery fixing with rack or cabinet, including 6 screws of M4, 4 sets of M6 screws and buckle nuts.	Hanging ears:2
5	3U-Bracket-B		Simple stacking bracket, with height of 180mm. 1 set includes 4 brackets and 8 screws of M4. The number of batteries stacked is 4 at most.	4pcs
6	Battery Wall-Mounted Brackets		Pair of simple wall hanging support, including 4 sets of M6 expansion screws.	2
7	M6*16 bolt and nut		Fix the battery on the rack or cabinet	4 sets
8	M6 Expansion		Fixed wall bracket	4
9	User Manual	/	/	1

3.2 Required Tools

These tools are required to install the battery.

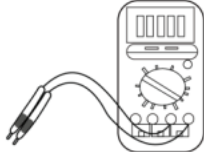
No.	Items	Usage	Appearance
1	Phillips Screwdriver or Bit	To fasten battery and assemblies	
2	Box Cutter	Opening boxes	
3	Insulated Torque Wrench	Installing cables and busbars	
4	Insulated Sockets	Installing cables and busbars	
5	Battery Tester	Measure battery module voltage	



Note:

Use properly insulated tools to prevent accident tale electric shock or short circuits. If insulated tools are not available, cover the entire exposed metal surfaces of the available tools, except their tips, with electrical tape.

3.2 Safety Gear

It is recommended to wear the following safety gear when dealing with the battery pack.



4 Installation Instructions

4.1 Installation Personnel

- Only qualified professionals or trained personnel are allowed to install the equipment.
 - Professionals:personnel who are familiar with the working principles and structure of the equipment, trained or experienced in equipment operations and are clear of the sources and degree of various potential hazards in equipment installation.
 - Trained personnel:personnel who are trained in technology and safety have required experience,are aware of possible hazards on themselves in certain operations and are able to take protective measures to minimize the hazards on themselves and other people.
- Personnel who plan to install the equipment must receive all necessary safety precautions and local relevant standards.
- Only qualified professionals are allowed to remove safety facilities and inspect the equipment.
- Knowledge of electronic, electrical wiring and mechanical expertise, and be familiar with electrical and mechanical schematics.
- Understanding and complying with this document and other applicable documents.

4.2 Installation Environment



Do not expose the equipment to flammable or explosive gas or smoke. Do not perform any operation on the equipment in such environments.



Do not store any flammable or explosive materials in equipment area.Do not cover or wrap the battery.

 **Danger !**

Do not place the equipment near heat sources or fire sources, such as smoke, candles, heaters, or other heating devices. Overheat may damage the equipment or cause a fire.

 **Warning !**

Install the equipment in an area far away liquids. Do not install it under areas prone to condensation, such as under water pipe and air exhaust vent, or area prone to water leakage, such as air conditioner vents, ventilation vents, or feeder windows of the equipment room. Ensure that no liquid enters the equipment to prevent faults or short circuits.

 **Warning !**

To prevent damage or fire due to high temperature, ensure that the ventilation vents or heat dissipation systems are not obstructed or covered by other objects while the equipment is running.

- The installation and usage environment must meet relevant international, the local laws and regulations. The user is obliged to protect the equipment against fire or other hazards.
- Keep the equipment out of the reach of children and away from daily working or living area, including but not limited to the following areas: studio, bedroom, lounge, living room, music room, kitchen, game room, room theater, sunroom, toilet, bathroom, laundry, and attic.
- Do not install the equipment in places that are enclosed, poorly-ventilated without proper fire fighting facilities, or difficult for firefighters to access.
- Do not install the equipment in an easily accessible position because the temperature of the enclosure and heat sink is high when the equipment is running.
- Do not install the equipment on a moving object, such as ship, train, or car.
- Ensure that the equipment is installed in a clean, dry and well ventilated area with proper temperature, humidity and altitude range. Check for more data in the "Technical Specifications" section.
- Do not install the equipment in an environment with magnetic dust, volatile or corrosive gases, infrared and other radiations, organic solvents, conductive metal, or salty air.
- Do not install the equipment in an area conducive to growth of microorganism such as fungus or mildew.
- Do not install the equipment in an area with strong vibration, noise, or electromagnetic interference.
- Do not install the equipment in an position that may be submerged in water.
- Keep away from the air outlet of PCS to prevent personal injury..
- The floor and walls are completely water proof.
- The wall and floor is flat and level.
- Before installing and powering up the system, dust and iron filings must be removed to keep the environment clean. The system cannot be installed in desert areas without a shell to protect against sand.
- The equipment is designed for indoor use. Please avoid direct sunlight, rain exposure, snow laying up during installation and operation.

⚠ Caution !

Moving heavy objects.

Be careful to prevent injury when moving heavy objects. Select an suitable way to moving heavy objects according to product weight.

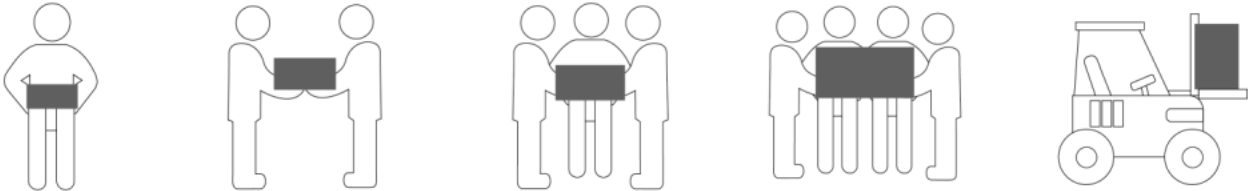

Weight	Method	Recommendation
<18 kg (40lbs)	Manual handling	1 person
18~32 kg (40~70lbs)	Manual handling	2 persons
32~55 kg (40~70lbs)	Manual handling	3 persons
55~68 kg (121~150lbs)	Manual handling	4 persons
> 68 kg (150lbs)	Moving device	Forklift

4.3 Installing the Battery

⚠ Note !

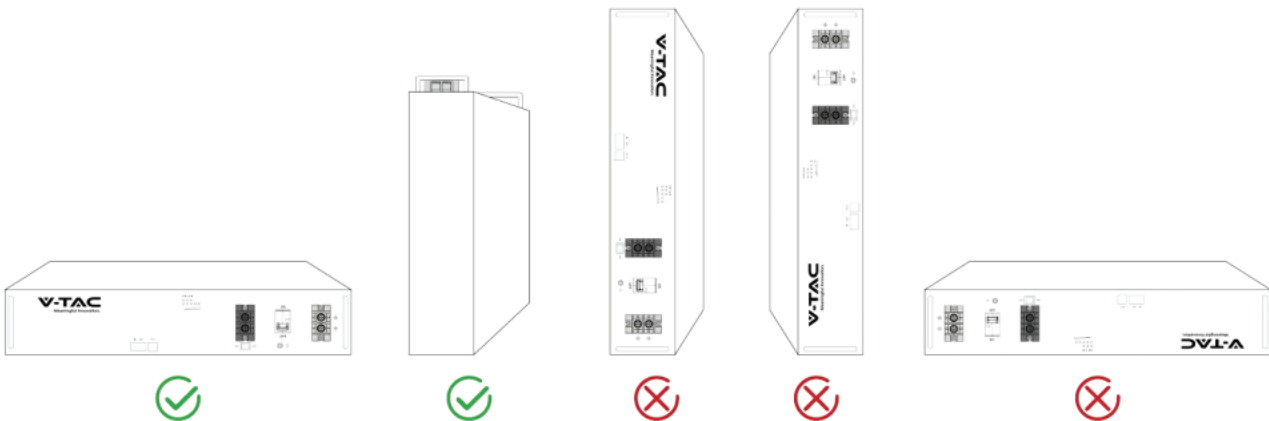

4.3.1 Wall-mounted

1. Choose appropriate locations on the wall and then drill 4 assembly holes on the wall prior to battery installation.

⚠ Note!

1) When drilling holes, pay attention to prevent dust from entering the battery, which may affect the battery performance and function.

2) After drilling, never forget to clean up the floor.

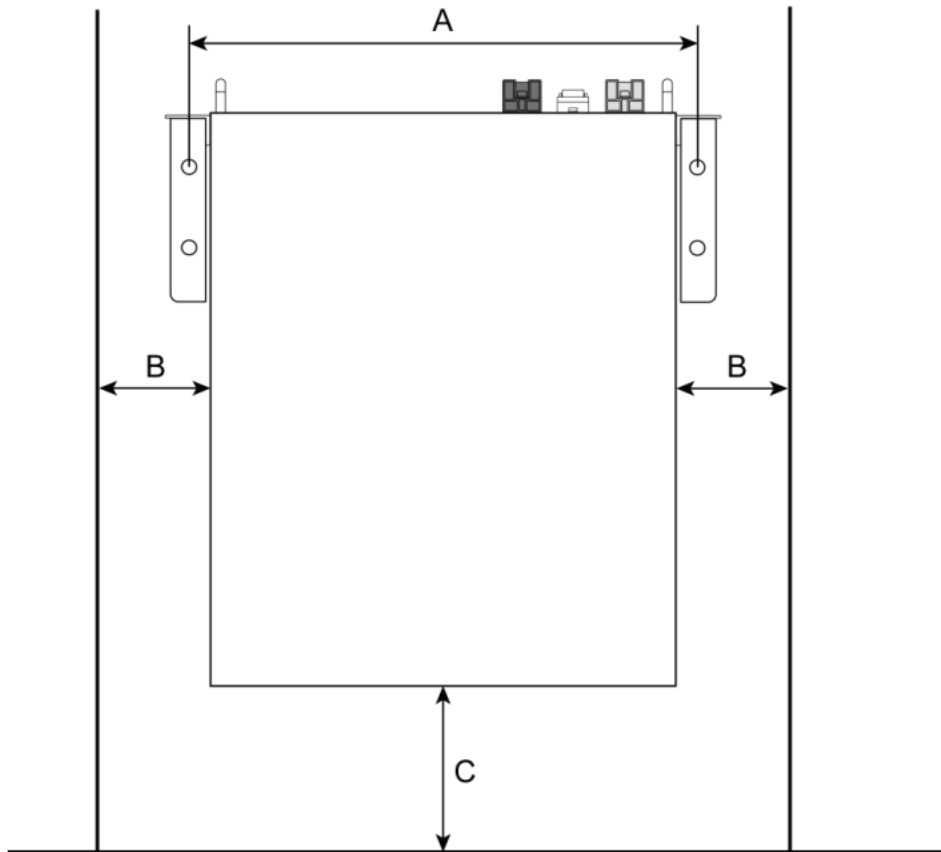

Item	Distance (mm)
A	482 ± 2
B	≥ 200
C	≥ 400

2. Use the 6 screws of M4*8 to fix two hanging ears onto two sides of the battery.

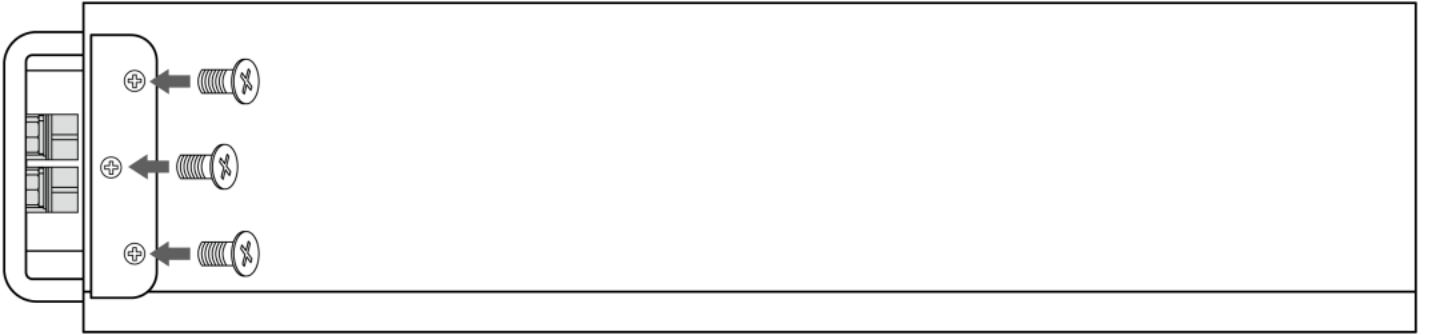

3. Fix two wall-mounted brackets onto the wall with 4 expansion bolts (M6*100).

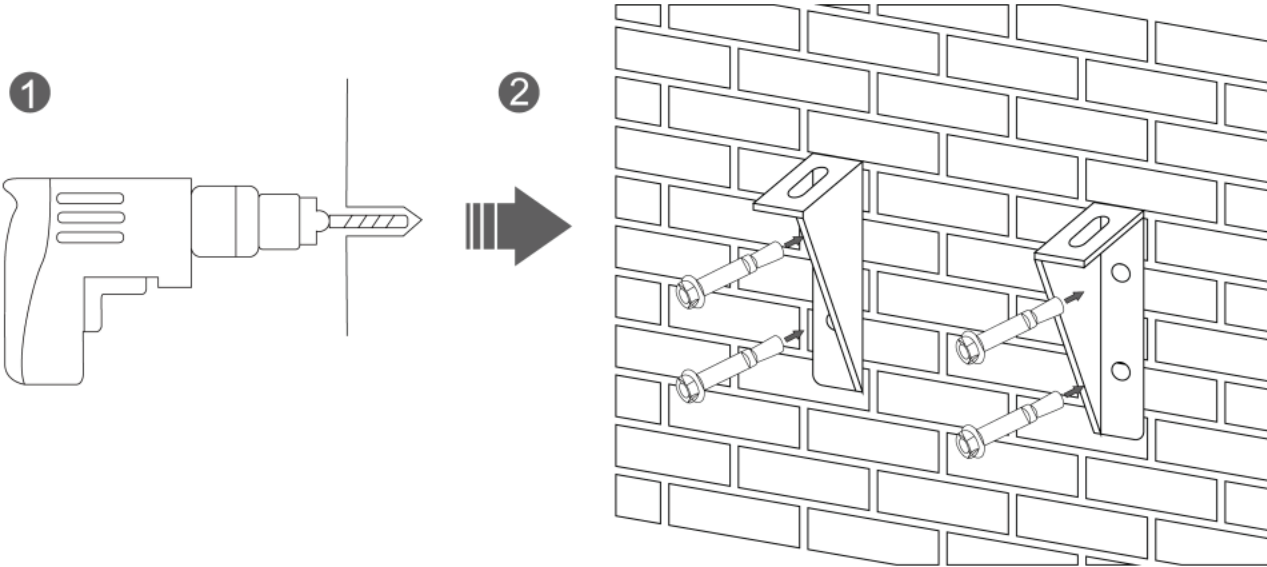

4. Carry the battery and secure the battery to the wall-mounted brackets using 4 sets of M6 screws and buckle nuts.

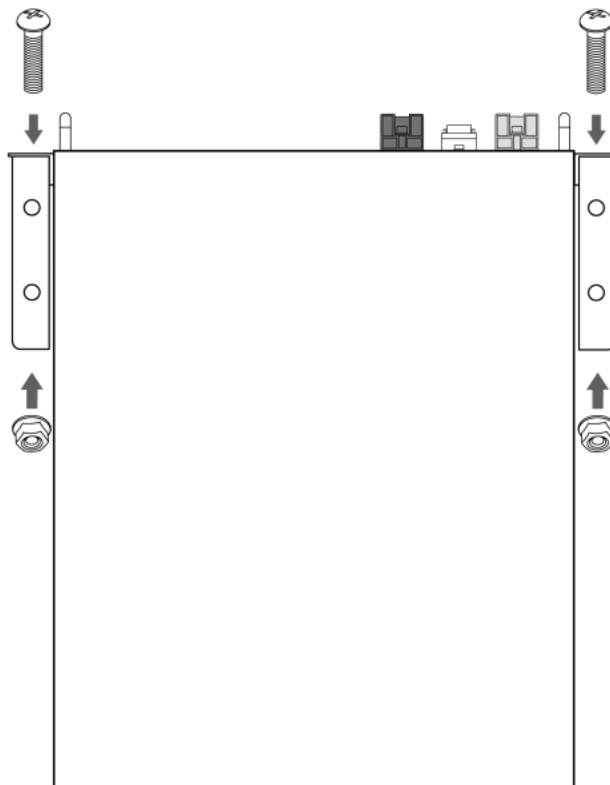

4.3.2 Floor-mounted

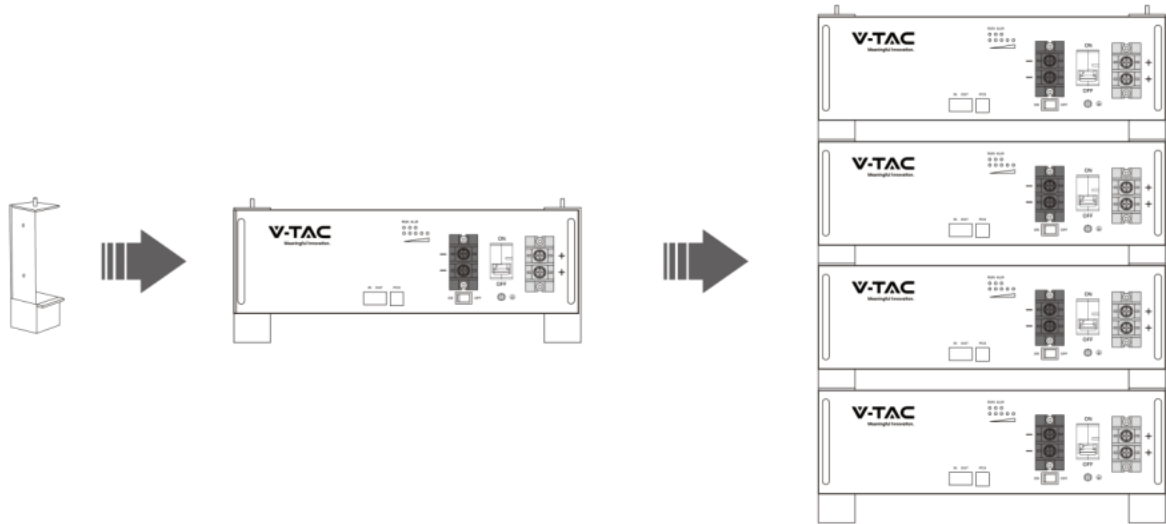

4.3.3 Rack-mounted

It is recommended to put your batteries in place with a standard 19-inches cabinet.

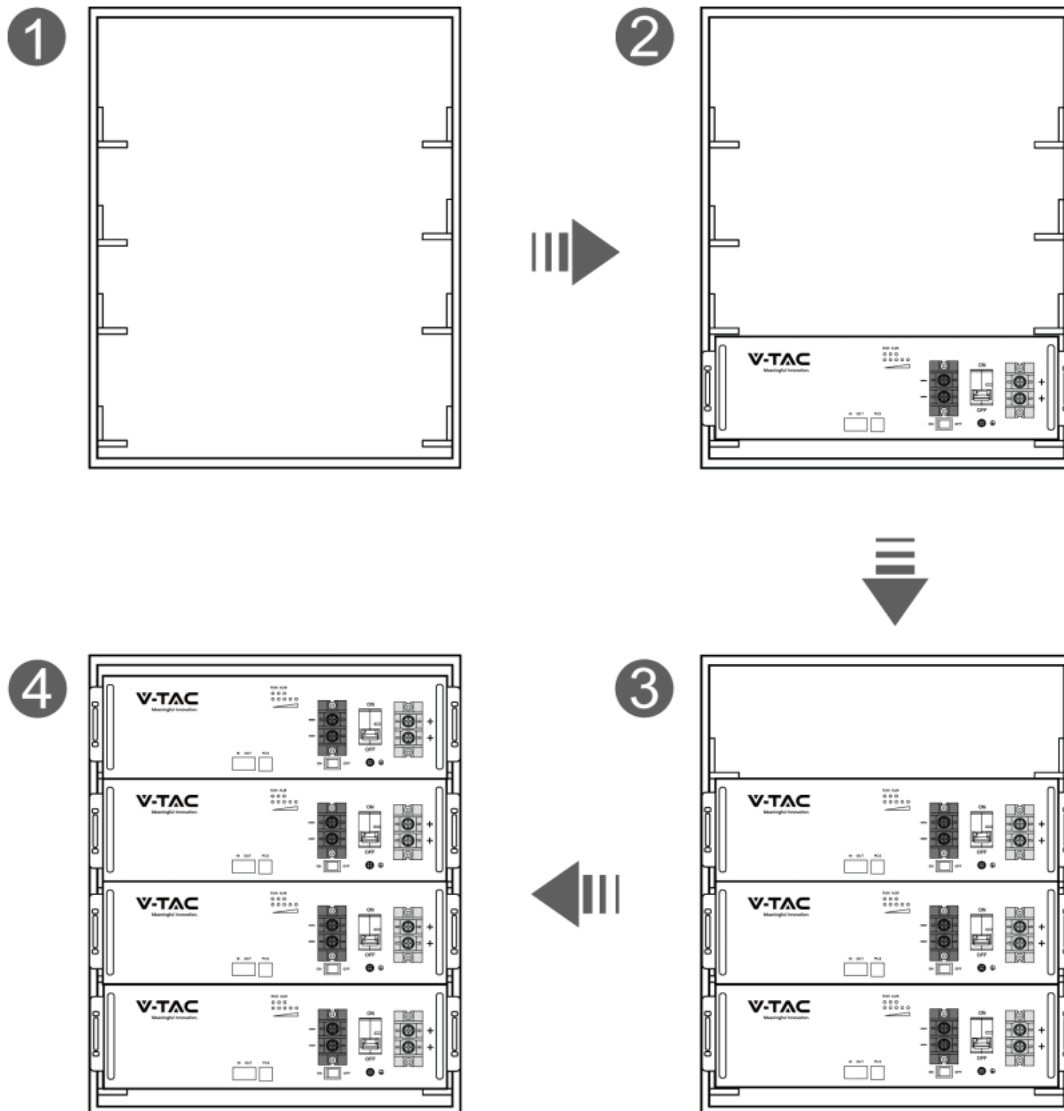

5. Electrical Connection

Note!

- It is noted to distinguish the positive and negative ends of cables.
- Be careful to avoid misuse of lines used for communication between PCS and battery, battery and battery.
- Try to avoid cross-connection.
- Before connect the cable with the PCS, the worker must confirm the output switch of the PCS has been turn off, to prevent the risk of fire or electric shock.
- Exercise extreme caution to prevent the terminals from contacting anything except their intended mounting points.
- When tightening the screws, make sure they are at a straight angle from the battery module terminals to avoid damage to the nuts inside.
- The power terminals, such as "+," "-," of the module are covered with the protecting cover to guard against a short circuit.
- You must remove the insulation cover prior to connecting and reattach the insulation cover immediately after connecting.

5.1 Wiring

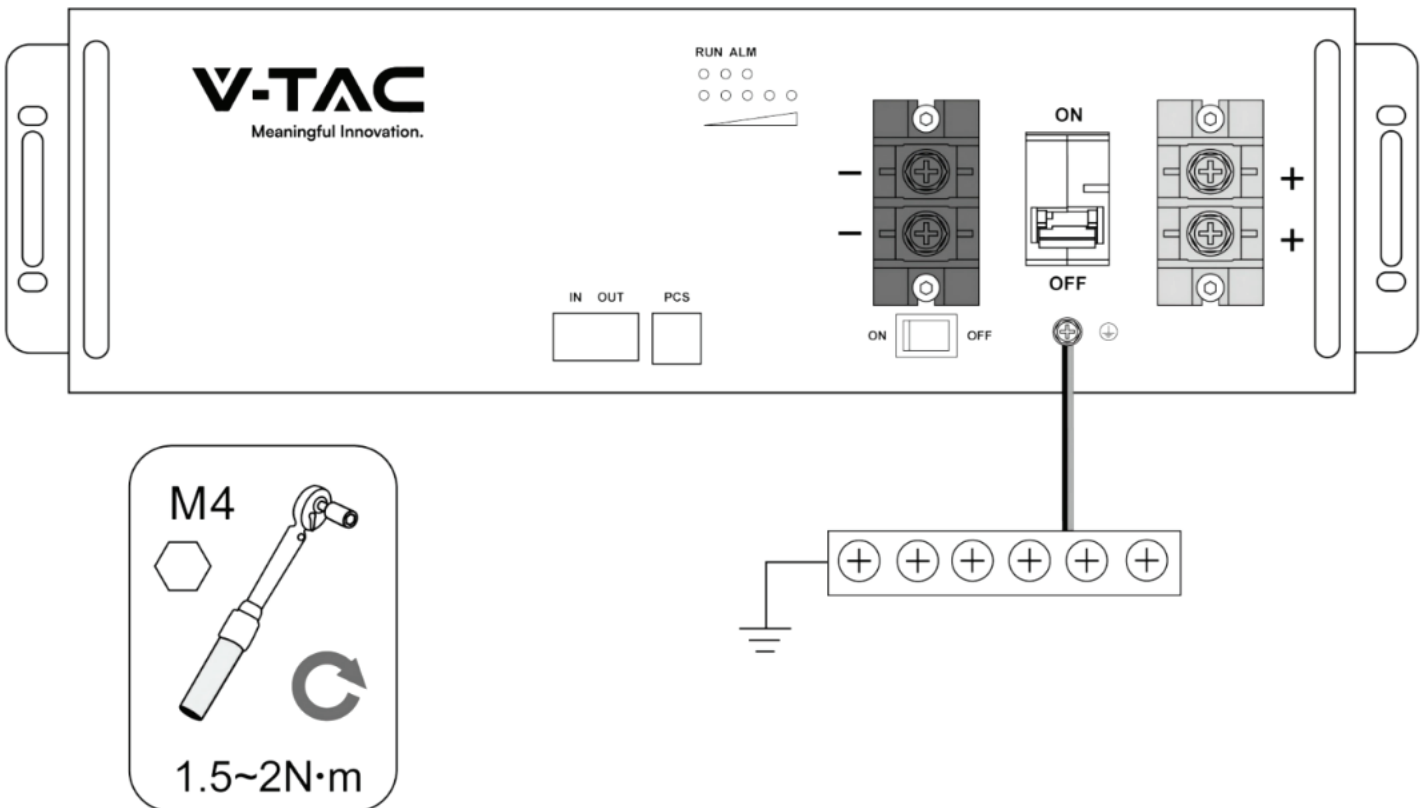

Step 1 Wear the protective gloves.

Step 2 Remove the ground screw using a socket wrench, and then install the ground cable and the screw.

Step 3 Install negative and positive power cables as the following steps:

- 1) Remove the protective cover from terminals.
- 2) Remove the negative terminal screw using a screwdriver, connect one end of negative power cable to the negative socket, and then install the screw.
- 3) Remove the positive terminal screw using a screwdriver, connect one end of positive power cable to the positive socket, and then install the screw.
- 4) Install the other end of the battery power cables to corresponding terminals of another battery and the busbar in the power system.
- 5) Reinstall the protective cover on the battery power terminals.

5.2 Connecting to PCS

Connect the inverter:

- 1) Remove the protective cover.
- 2) Remove the positive terminal screw using a screwdriver, connect one end of positive power cable to the positive socket of the battery and another end to the positive terminal of the PCS. After wiring, fasten the screw immediately to avoid dropping.

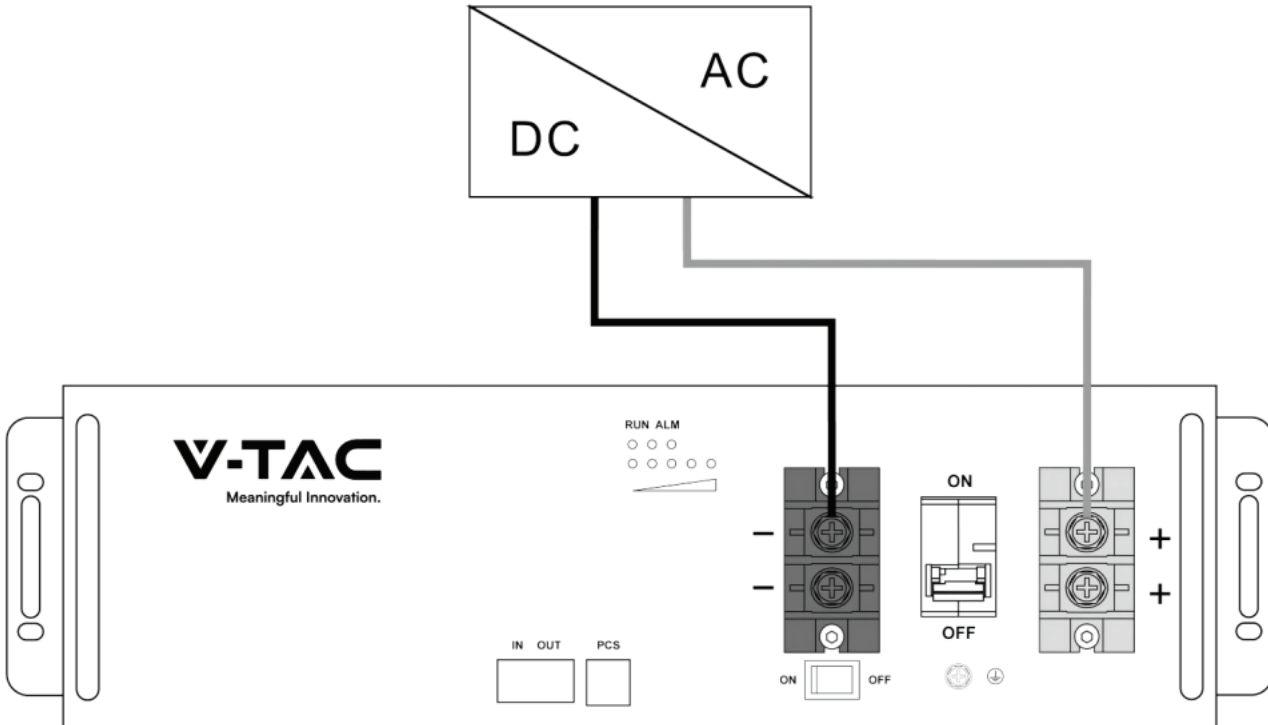

- 3) Remove the negative terminal screw using a screwdriver, connect one end of negative power cable to the negative socket of the battery and another end to the negative terminal of the PCS. After wiring, fasten the screw immediately to avoid dropping.
- 4) Reinstall the protective cover after all wires are connected correctly and firmly.
- 5) Sort the cables and fasten battery power cables to the perforated bracket with cable ties.

- 6) Insert one end of the communication cable into the PCS port of the battery and another end to the BMS port of the PCS

When monitoring batteries by the computer, carry out the wiring as shown in the following picture.

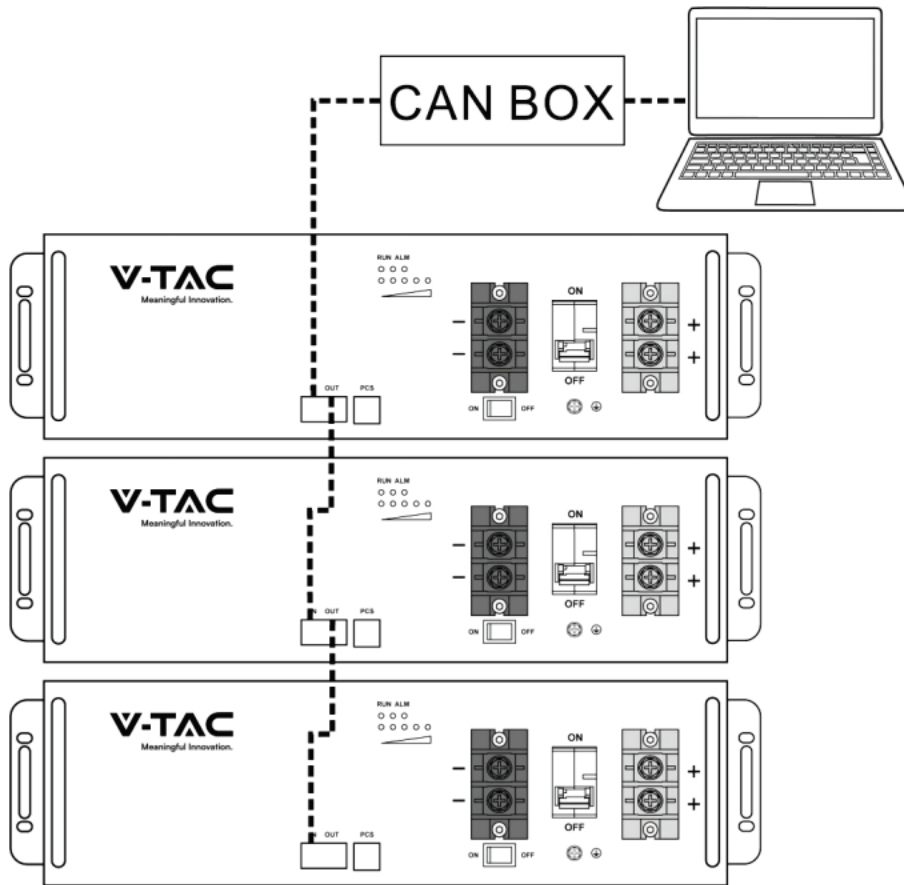

5.3 Parallel Mode



When batteries need to be used together in parallel, you can select different parallel modes to meet your demands.

5.3.1 Mode 1

Caution!

1. It should be noted that the maximum current of single battery system is **100A**. Exceeding 100A will cause heating of the connectors and cable, and in severe cases, it will cause a fire accident. As for cables, the recommended cross section of them should be at least **4AWG** or **25mm²**.

Schematic diagram of connection of single battery system:

-  Battery positive line
-  Battery negative line
-  Communication line

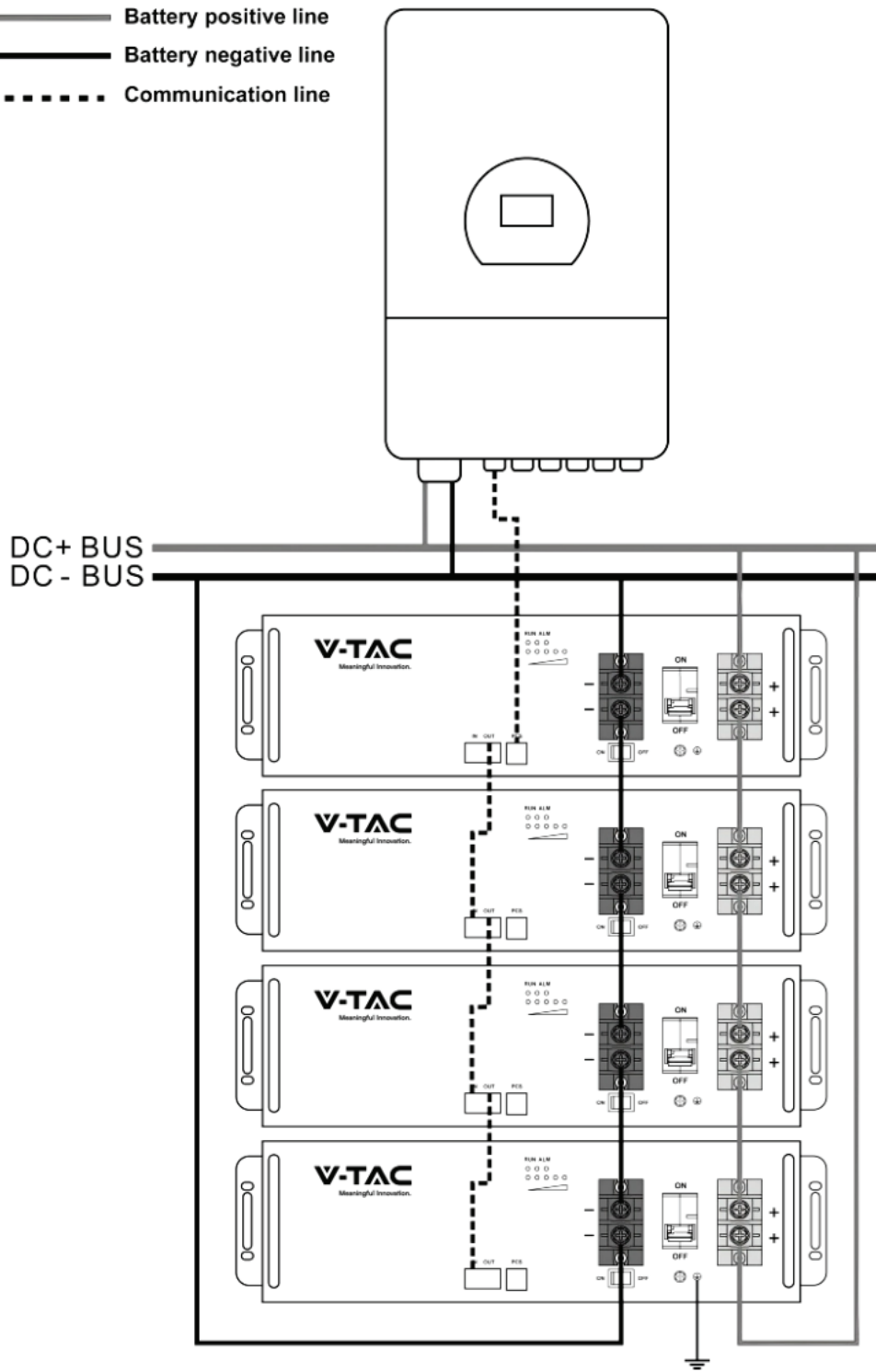

5.3.2 Mode 2

Schematic diagram of parallel connection of high-power system batteries:

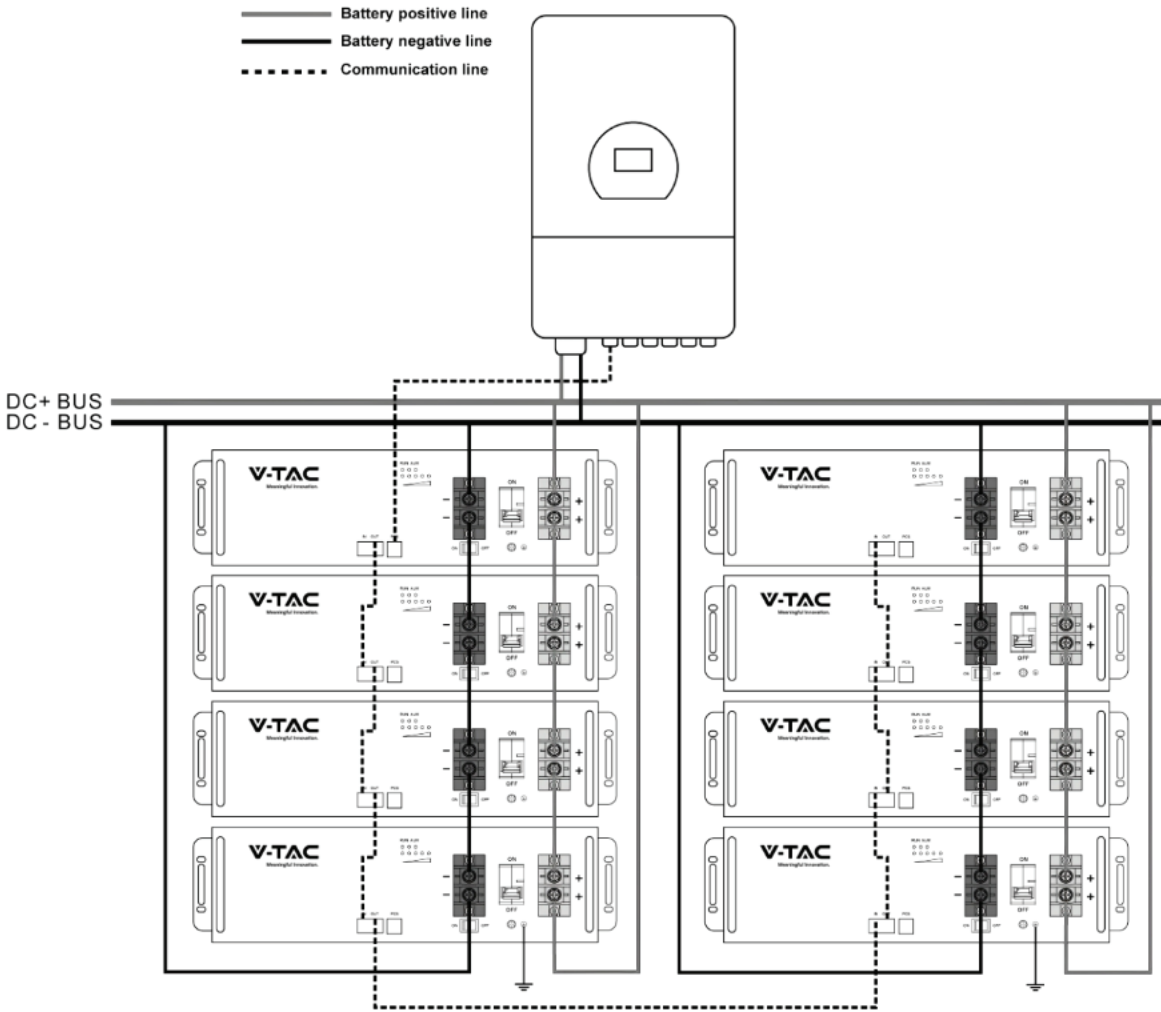

Or larger capacity systems:

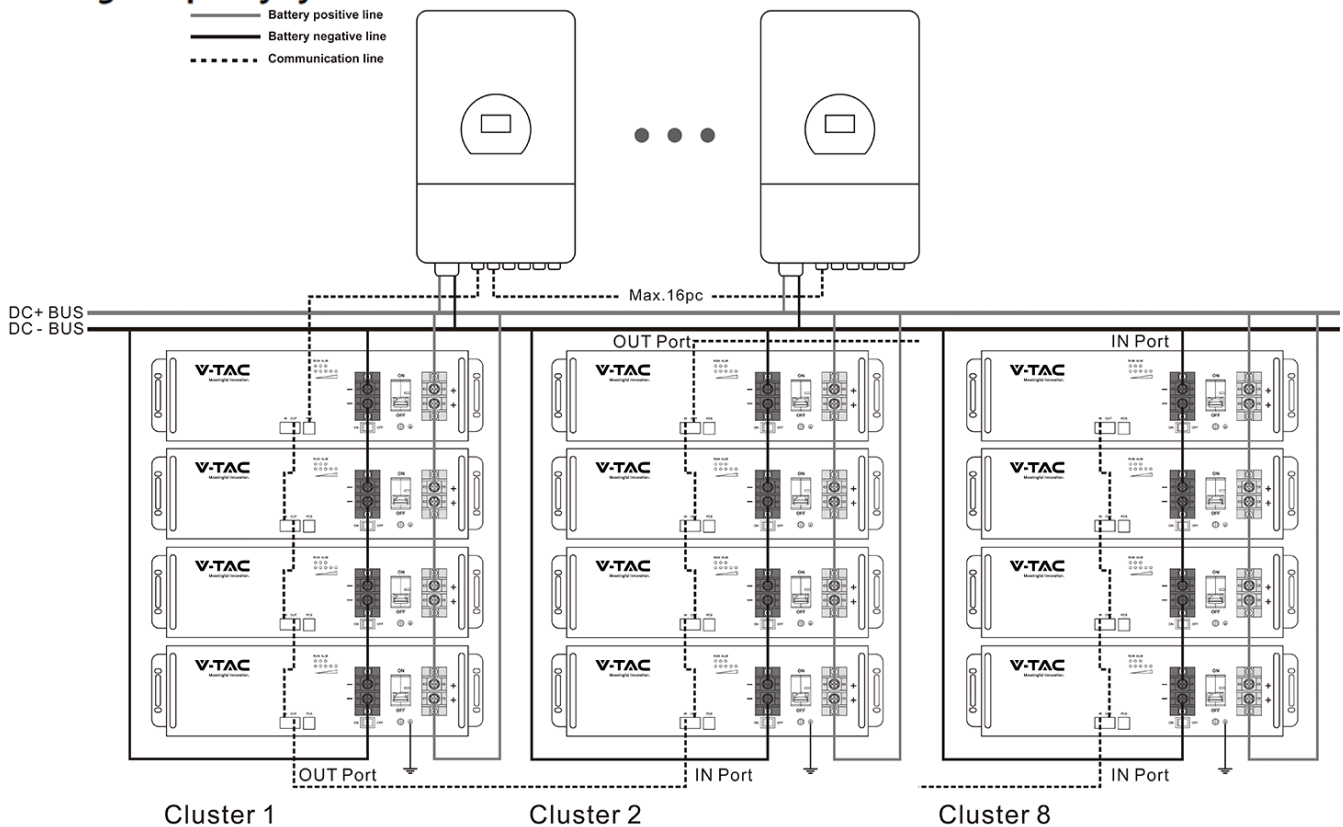

6 Power on/off the Product

Before operating the product, ensure that:

- All cables are wired correctly and firmly.
- All fasteners including bolts and screws are tightened firmly.
- No bystanders or animals enter into the working area.
- Keep foreign objects , especially metal, away from the battery .

1. Turn the circuit breaker to the "ON" position.

2. Turn on the BMS switch.

3. After you finish your work, please switch off the BMS switch ,and then the circuit breaker.

7 Inspection, Cleaning and Maintenance

7.1 General Information

- The battery product is not fully charged. It is recommended that the installation be completed within 3 months after arrival;
- During the maintenance process, do not re-install the battery in the battery product. Otherwise, the performance of the battery will be reduced;
- It is forbidden to dismantle any battery in the battery product, and it is forbidden to dis- sect the battery;
- After the battery product is over-discharged, it is recommended to charge the battery within 48 hours. The battery product can also be charged in parallel. After the battery product is connected in parallel, the charger only needs to connect the output port of any product battery.
- Never attempt to open or dismantle the battery! The inside of the battery does not contain serviceable parts.
- Disconnect the Li-Ion battery from all loads and charging devices before performing cleaning and maintenance activities.
- Place the enclosed protective caps over the terminals before cleaning and maintenance activities to avoid the risk of contacting the terminals.
- All the battery terminals must be disconnected for maintenance.
- Please contact the supplier within 24 hours if there is something abnormal.
- Do not use cleaning solvents to clean battery.

7.2 Inspection

- Inspect for loose and/or damaged wiring and contacts, cracks, deformations, leakage, or damage of any other kind. If damage to the battery is found, it must be replaced. Do not attempt to charge or use a damaged battery. Do not touch the liquid from a ruptured battery.

- Regularly check the battery' s state of charge. Lithium Iron Phosphate batteries will slowly self-discharge when not in use or whilst in storage.
- Consider replacing the battery with a new one if you note either of the following conditions:
 - The battery run time drops below 70% of the original run time.
 - The battery charge time increases significantly.

7.3 Cleaning

If necessary, clean the Li-Ion battery with a soft, dry cloth. Never use liquids, solvents, or abrasives to clean the Li-Ion battery.

7.4 Maintenance

The Li-Ion battery is maintenance-free. Charge the battery to approximately > 80% of its capacity at least once every year to preserve the battery capacity.

8 Storage

- The battery product should be stored in a dry, cool, and cool environment;
- If the battery is stored for long time, it is required to charge them every six months, and the SOC should be no less than 50%.
- Generally, the maximum storage period at room temperature is 6 months. When the battery is stored over 6 months, it is recommended to check the battery voltage. If the volt- age is higher than 51.2V, it can continue to store the battery. In addition, it is needed to check the voltage at least once a month until the voltage is lower than 51.2V. When the voltage of the battery is lower than 51.2V, it must to be charged according to the charging strategy.
- The charging strategy is as follows: discharge the battery to the cutoff voltage with 0.2C(20A) current, and then charge with 0.2C(20A) current for about 3 hours. Keep the SOC of the battery at 40% ~ 60% when stored;
- When the battery product is stored, the source of ignition or high temperature should be avoided and it should be kept away from explosive and flammable areas.

9 Troubleshooting

To determine the status of the battery system, users must use additional battery status monitoring software to examine the protection mode. Refer to the installation manual about using the monitoring software. Once the user knows the protection mode, refer to the following sections for solutions.

Fault Type	Phenomenons	Possible Causes	Solutions
Information collection fails	The cell voltage sampling circuit is faulty. The cell temperature sampling circuit is faulty	The welding point for cell voltage sampling is loose or disconnected. The voltage sampling terminal is disconnected. The cell temperature sensor has failed.	Replace the collection line.
Electrochemical cell error	The voltage of the cell is low or unbalanced.	Due to large self-discharge, the cell over discharges to below 2.0V after long term storage. The cell is damaged by external factors, and short circuits, pinpricks, or crushing occur.	Replace the battery.
Over-voltage protection fails	The cell voltage is greater than 3.62 V in charging state. The battery voltage is greater than 57.6 V.	The busbar input voltage exceeds the normal value. Cells are not consistent. The capacity of some cells deteriorates too fast or the internal resistance of some cells is too high.	If the battery cannot be recovered due to protection against abnormality contact local engineers to rectify the fault.
Under voltage protection fails	The battery voltage is less than 44.8V. The minimum cell voltage is less than 2.8V	The mains power failure has lasted for a long time. Cells are not consistent. The capacity of some cells deteriorates too fast or the internal resistance of some cells is too high.	Same as above.
Charge or discharge high temperature protection fails	The maximum cell temperature is greater than 60°C	The battery ambient temperature is too high. There are abnormal heat sources around	Same as above.
Charge low temperature	The minimum cell temperature is less	The battery ambient temperature is too low.	Same as above.

protection fails	than 0°C		
Discharge low temperature protection fails	The minimum cell temperature is less than -20°C	The battery ambient temperature is too low.	Same as above.

10 Technical Specifications

Main Parameter		VT-51201-B
Battery Chemistry		LiFePO ₄
Nominal Capacity (Ah) ¹		100
Nominal Voltage (V)		51.2
Operating Voltage(V)		44.8~57.6
Nominal Energy (kWh) ¹		5.12
Cell Configuration		1P16S
Scalability ²		Max. 64 pcs pack (327kWh) in parallel
Charge/Discharge Current (A) ³	Max. Continuous	100
	Peak	200A(10 sec)
Other Parameter		
Recommend Depth of Discharge		90% DoD
Dimension (W/H/D, mm)		440×133×540
Weight Approximate(kg)		44
Master LED indicator		5LED(SOC:20%~100%)
		3LED (working, alarming, protecting)
IP Rating of enclosure		IP20
Working Temperature		Charge:0°C~55°C Discharge:-20°C~55°C
Storage Temperature		0°C~35°C
Humidity		95%
Altitude		≤2000m
Cycle Life		≥6000(25°C±2°C,0.5C/0.5C,90%DOD,60%EOL)
Installation		Wall-Mounted, Floor-Mounted (Stacked) , Rack-Mounted (cabinet depth ≥ 600mm)
Communication Port		CAN2.0, RS485
Certification		UN38.3,MSDS
Color		VT-51201-B: Black

[1] Test conditions : 25°C±2°C, at beginning of life, 0.5C charge & 0.5C discharge,100% DOD.

[2] Max. 32 pcs without external CAN-Box.

[3] The current is affected by temperature and SOC.

11 Environmental Disposal

Used batteries can not be disposed of as household waste. You are obliged to handle waste batteries, such as removal of privacy on product, and return them to designated or authorized recovery point according to applicable regulations and standards on waste battery disposal.



Attention:

1. Do not dispose of batteries and rechargeable batteries as domestic waste! You are legally obliged to return used batteries and rechargeable batteries.
2. Waste batteries may contain pollutants that can damage the environment or your health if improperly stored or handled.
3. Batteries also contain iron, lithium and other important raw materials, which can be recycled.

For more information, please contact our dealer or local vendor from whom you have purchased the product. Do not dispose of batteries as household waste!



Li-ion



12 Transportation Requirements

1. The battery products should be transported after packaging and during the transportation process. Severe vibration, impact, or extrusion should be prevented to prevent sun and rain. It can be transported using vehicles such as cars, trains, and ships.
2. Always check all applicable local, national, and international regulations before transporting a Lithium Iron Phosphate battery.
3. Transporting an end-of-life, damaged, or recalled battery may, in certain cases, be specially limited or prohibited.
4. The transport of the Li-Ion battery falls under hazard class UN3480, class 9. For transport over water, air and land, the battery falls within packaging group PI965 Section I. Use Class 9 Miscellaneous Dangerous Goods and UN Identification labels for transportation of lithium-ion batteries which are assigned Class 9. Refer to relevant transportation documents.



Class 9 Miscellaneous Dangerous Goods and UN Identification Label

13 EU Declaration of Conformity

within the scope of the EU directives

- Electromagnetic compatibility 2014/30/EU (EMC)

VTAC EUROPE LTD confirms herewith that the products described in this document are in compliance with the fundamental requirements and other relevant provisions of the above mentioned directives.



EU Declaration of Conformity

Product: Rechargeable Li-ion Battery System

Models: VT-51201-W, VT-51201-B

Name and address of the manufacturer: V-TAC EXPORTS LIMITED

FLAT/RM D-27/F WING CHEONG COMMERCIAL BLDG 19-25 JERVOIS STREET SHEUNG WAN Hongkong

Name and address of the importer: VTAC EUROPE LTD

Bulgaria, Plovdiv 4000, bul.L.Karavelow 9B

This declaration of conformity is issued under the sole responsibility of the manufacturer. Also this product is under manufacturer's warranty.

This declaration of conformity is not valid any longer: if the product is modified, supplemented or changed in any other way, as well as in case the product is used or installed improperly.

The object of the declaration described above is in conformity with the relevant Union harmonization legislation: The Electromagnetic Compatibility (EMC) Directive 2014/30/EU.

References to the relevant harmonized standards used or references to the other technical specifications in relation to which conformity is declared:

EMC:	
EN IEC 61000-6-1:2019	●
EN IEC 61000-6-3:2021	●

Nom et Titre / Name and Title:

SATISH PARSHOTTAM SAJNANI
CEO

Authorized on behalf of
V-TAC EXPORTS LIMITED
威迪贸易有限公司

Au nom de / On behalf of:

Date / Date (yyyy-mm-dd):

A / Place :

V-TAC EXPORTS LIMITED

2025-3-11

Hong Kong, China

Authorized Signature(s)

EU DoC-v1

VTAC EXPORTS LIMITED.
FLAT/RM D-27/F WING CHEONG COMMERCIAL BLDG 19-25 JERVOIS STREET SHEUNG WAN Hongkong

IMPORTANT NOTES

- This product contains battery type "Secondary" (rechargeable).
- Electrical and electronic equipment that has become waste is known as old equipment/device. Old devices must not be disposed of with other household waste.
- Owners of old devices at the end of its service life must return the device by taking them to the collection points set up by public waste disposal authorities or distributors. This return does not entail any costs for you.
- Owners of old devices have an obligation to remove accessible batteries / rechargeable batteries as well as non-destructively removable lamps from the old device prior to return. This does not apply if old devices are being prepared for reuse with the participation of a public law firm.
- Battery removal warning: The battery contained in this product must be removed only by professional personnel only. The battery must never be removed by the end user, if not removed correctly it could damage the battery which could cause fire.
- Batteries removed from an old electronic device should be disposed of separately. This return of battery does not entail any costs for you and the user is obliged to return the battery.
- Please make sure that this product is not powered on when removing the battery. Fire hazard! Avoid short-circuiting the contacts of a detached battery. Do not incinerate the battery. Please handle the battery with Caution!
- If electrical appliances or batteries are disposed of in landfills or dumps, hazardous substances can leak into the groundwater and get into the food chain, damaging your health and well-being.



- The symbol of "Crossed rubbish bins "indicates that this product should not be disposed of with other household wastes and must be collected separately from unsorted municipal waste at the end of its service life.
- Please use the link below to view the online directory of the collection and return points:<https://www.ear-system.de/ear-verzeichnis/sammel-und-ruecknahmestellen>

V-TAC WEST EUROPE LTD. IN CASE OF ANY QUERY/ISSUE WITH THE PRODUCT, PLEASE REACH OUT TO US AT: SUPPORT@V-TAC.EU FOR MORE PRODUCTS RANGE, INQUIRY PLEASE CONTACT OUR DISTRIBUTOR OR NEAREST DEALERS. V-TAC WEST EUROPE LTD. GROUND FLOOR, 71 LOWER BAGGOT STREET, DUBLIN 02, IRELAND DO2 P593

V-TAC UK LTD. IN CASE OF ANY QUERY/ISSUE WITH THE PRODUCT PLEASE REACH OUT TO US AT SUPPORT@VTACEXPORTS.COM V-TAC, 5A TUNGSTEN PARK, DOWNS ROAD, WITNEY, OXFORDSHIRE, OX29 OAX
